



**HISUNG**  
INTERIOR

HISUNG INTERIOR  
**CATALOGUE**  
2021 - 2022

Synchronized interior space  
**HISUNG MODELS DESIGN**



**GIỚI THIỆU CHUNG**

INTRODUCTION

▶ 04

**TẠI SAO CHỌN HISUNG INTERIOR**

WHY CHOOSE HISUNG?

▶ 05

**DÒNG TỦ BẾP WOOD GRAIN**

WOOD GRAIN LINE

▶ 06

**DÒNG TỦ BẾP ELEGENT**

ELEGENT LINE

▶ 18

**DÒNG TỦ BẾP SURFACE DECOR**

DÉCOR SURFACE LINE

▶ 32

**TỦ QUẦN ÁO**

WARDROBE

▶ 40

**TỦ GIÀY**

SHOES SHOCKET

▶ 46

**TỦ LAVABO**

LAVABO CABINET

▶ 50

**PHỤ LỤC**

ADDENDUM

▶ 52

# HISUNG INTERIOR

## GIỚI THIỆU

### INTRODUCTION

Giải pháp nội thất từ **HISUNG INTERIOR** – thương hiệu quốc tế đến từ Hàn Quốc, cung cấp giải pháp nội thất phong cách Hàn Quốc, chất lượng quốc tế, tính năng vận hành đa dạng, vật liệu bền vững và phù hợp với thói quen nấu bếp của người Châu Á. Hisung Interior kết hợp tủ bếp với các loại phụ kiện chất lượng quốc tế, tương thích cao và tối ưu công năng, là lựa chọn tối ưu cho nhiều gia đình trẻ đang sở hữu căn hộ chung cư hiện đại và mong muốn tiết kiệm không gian.

Interior solutions from **HISUNG INTERIOR** - an international brand from Korea, we provide Korean style interior solutions, international quality, diverse operating features, material systems, and consistent with habits Asian cooking. Hisung Furniture combines interior cabinets with all kinds of international quality accessories, high compatibility and optimal use that is the optimal choice for many young families who own a modern apartment and want to save money.



## TẠI SAO LỰA CHỌN

### WHY CHOOSE HISUNG?

- Chất liệu đa dạng, trong đó sản phẩm khung Inox hoặc hợp kim bền bỉ là một thế mạnh
- Chất liệu cánh Inox, kính, gỗ - tùy nhu cầu
- Không gỉ sét, không nấm mốc, dễ lau chùi
- Tối ưu công năng, tiện dụng không gian
- Phù hợp thói quen của người Việt

- Diverse materials, in which durable stainless steel or alloy frame products are a strength
- Material of stainless steel wings, glass, wood - depending on needs
- No rust, no mildew, easy to clean
- Optimized function, convenient space
- In accordance with the habits of Vietnamese people

## NHÀ MÁY

### FACTORY

Các sản phẩm của **HISUNG INTERIOR** được sản xuất tại Nhà máy liên doanh tại Vinh Phúc - Việt Nam, từ nguyên phụ liệu nhập khẩu kết hợp cùng các thương hiệu uy tín trong nước trên dây chuyền công nghệ hiện đại chuyển giao từ Hàn Quốc. Hisung Interior tự hào là một trong số ít các đơn vị cung cấp trọn gói giải pháp nội thất tại Việt Nam từ nghiên cứu, sản xuất, thi công lắp đặt, bảo hành 24/7 không chỉ trong lĩnh vực Dự án trọng điểm, mà cả thị trường dân dụng theo thị hiếu từng khách hàng cụ thể.

**HISUNG INTERIOR** products system is manufactured at the joint venture factory in Vinh Phuc, Vietnam from imported raw materials - combined with reputable brands in the country on modern technology lines transferred from Korea. Hisung Interior is proud to be one of the whole interior cabinet solutions providers in Vietnam. We total do from research, production, construction, installation, supporting 24/7, and warranty not only in the important project area, that all the field use in the possible hospitality.



## DÒNG TỦ BẾP WOOD GRAIN

WOOD GRAIN LINE

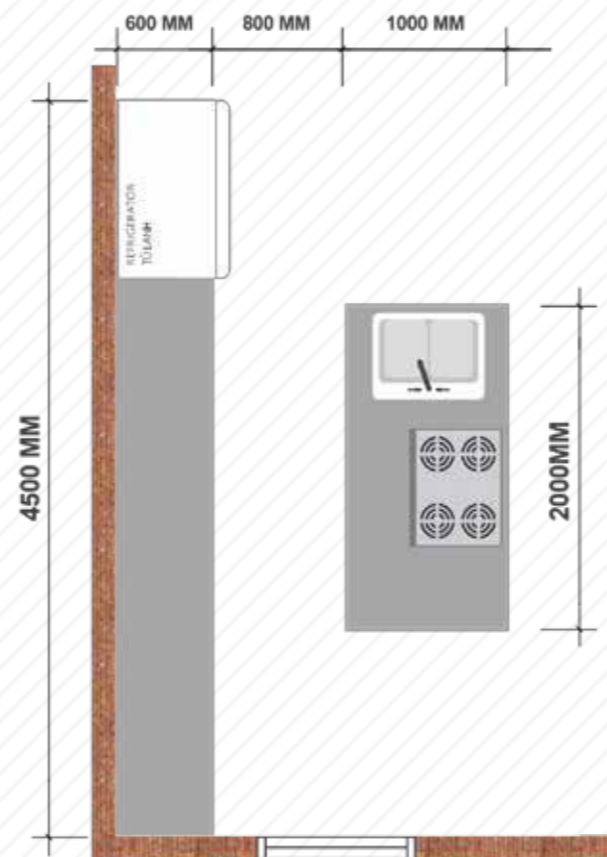



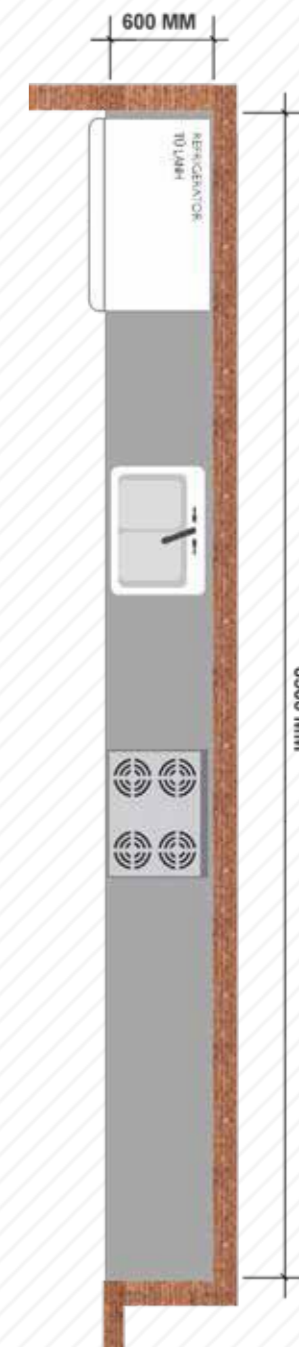



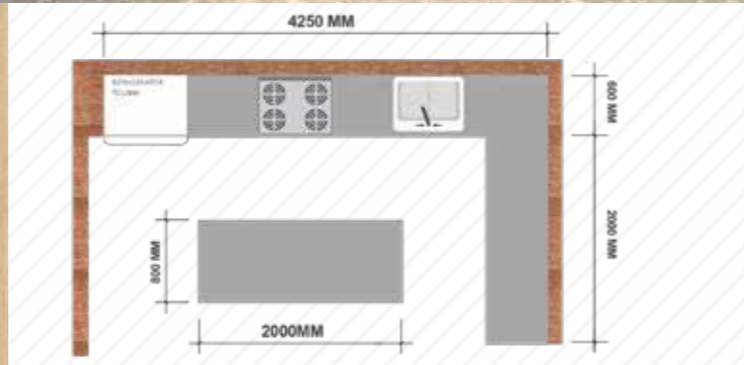



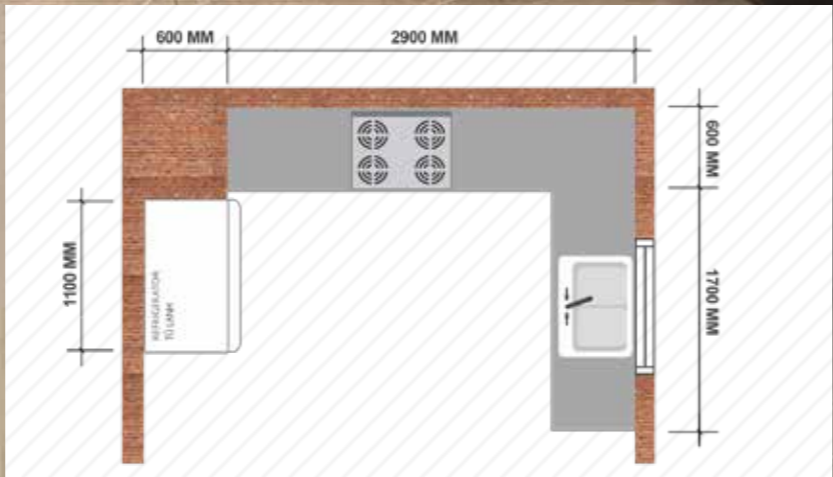



## DÒNG TỦ BẾP ELEGANT

ELEGANT LINE

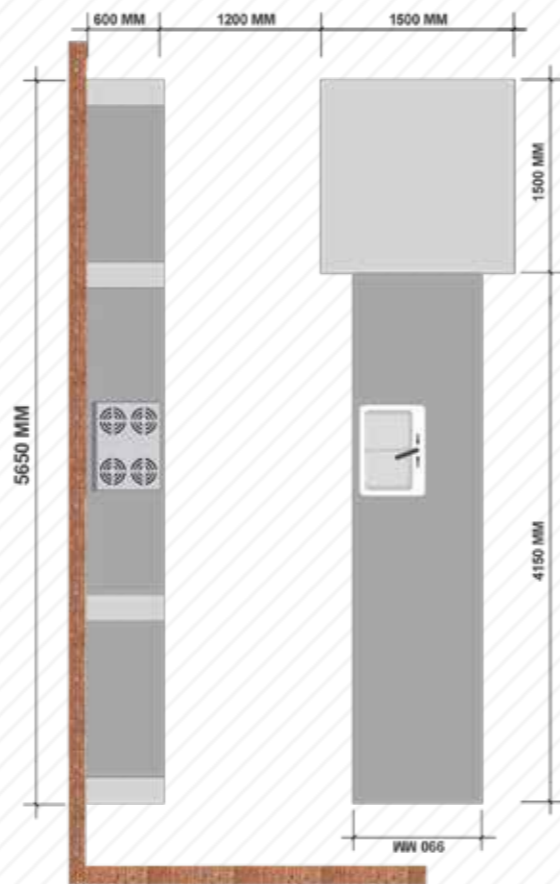





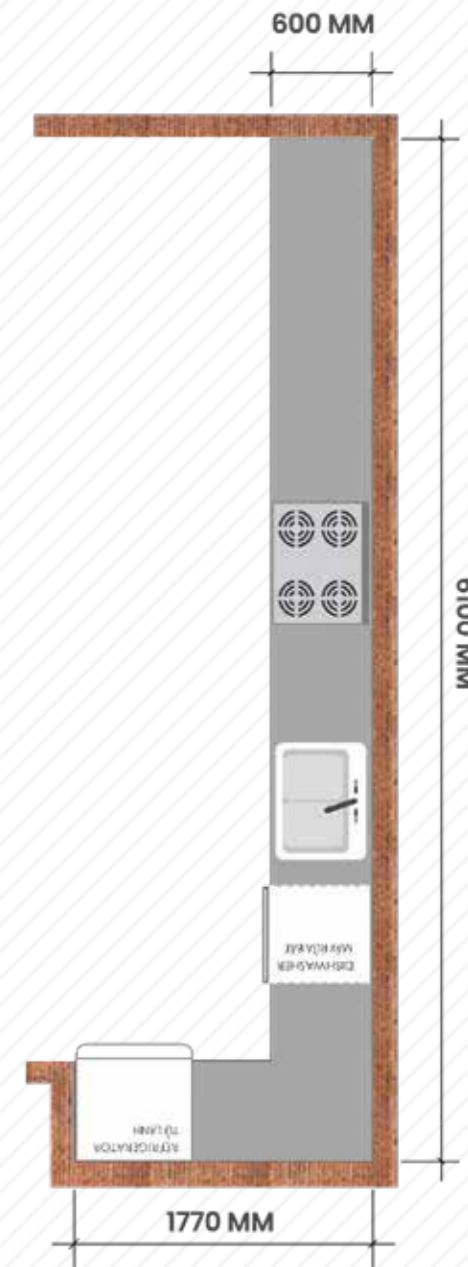

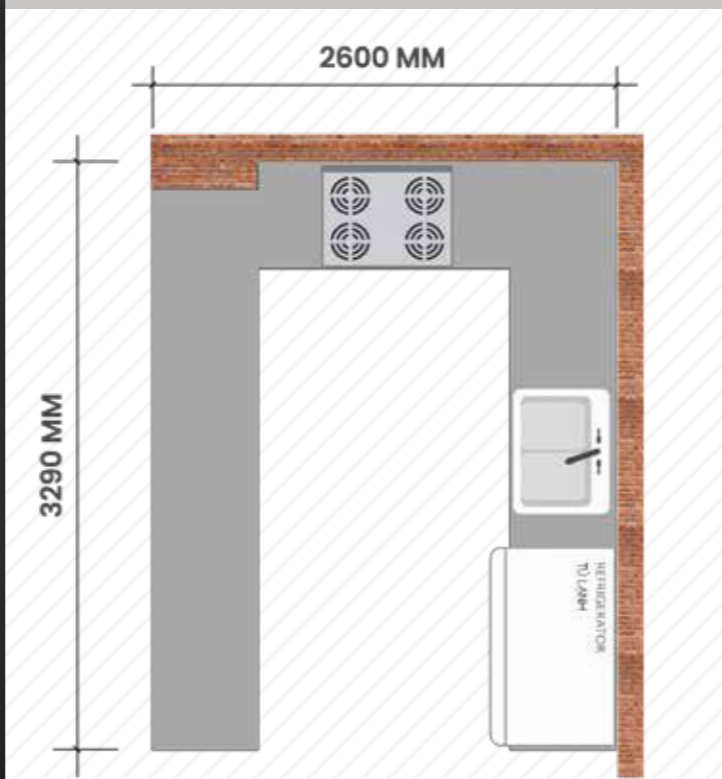









## DÒNG TỦ BẾP SURFACE DECOR

*DÉCOR SURFACE LINE*

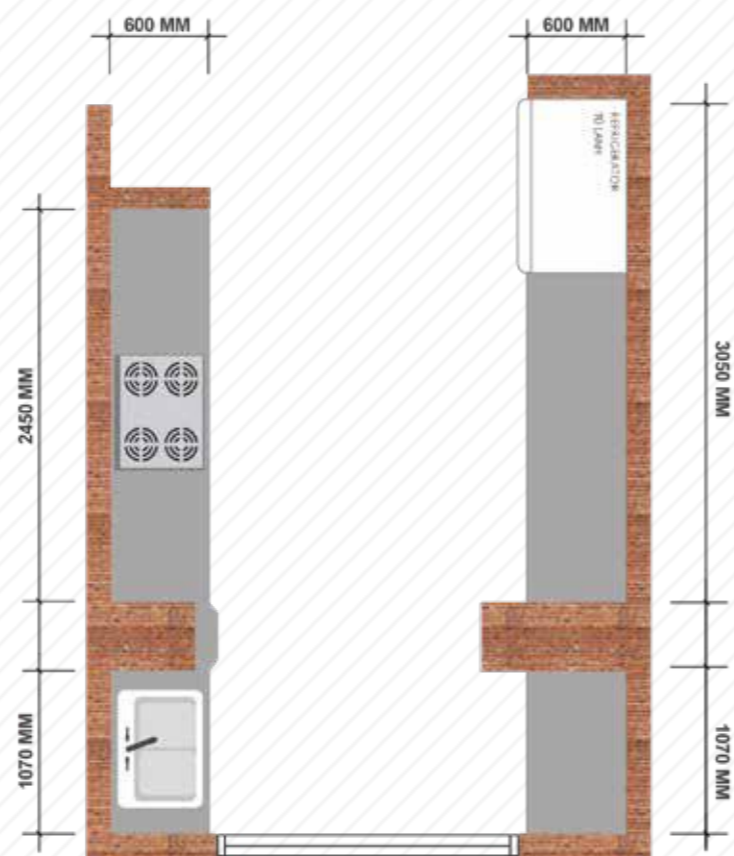





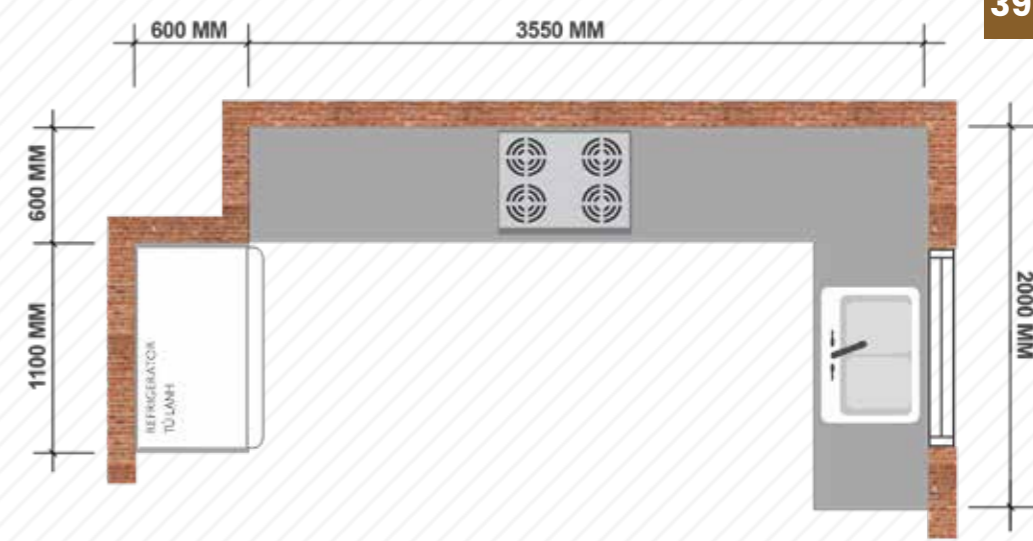



DÒNG TỦ ÂM TƯỜNG  
**TỦ QUẦN ÁO**  
WARDROBE





44



HISUNG INTERIOR [www.hisunginterior.com](http://www.hisunginterior.com)

45



Mã sản phẩm: **HS-BIW-003/WHITE**



DÒNG TỦ ÂM TƯỜNG  
**TỦ GIẦY**  
 SHOES SHOCKET





48



Mã sản phẩm: **HS-WSC-001**/GD603-85

49



Mã sản phẩm: **HS-WSC-002**/A7004-F0



Mã sản phẩm: **HS-WSC-003**/WHITE

Mã sản phẩm: **HS-LC-001**/GREY



## DÒNG TỦ LIỀN TƯỜNG TỦ LAVABO

LAVABO CABINET

Mã sản phẩm: **HS-LC-002**/UR901-U3



Mã sản phẩm: **HS-LC-003**/MT104

## PHỤ LỤC CHẤT LIỆU

MATERIAL SOLUTION



## CHẤT LIỆU CỐT TẤM

SHEET MATERIAL



MFC chống ẩm



MDF chống ẩm



PVC foam



INOX

## CHẤT LIỆU BỀ MẶT LAMINATE VÂN GỖ

SURFACE MATERIAL

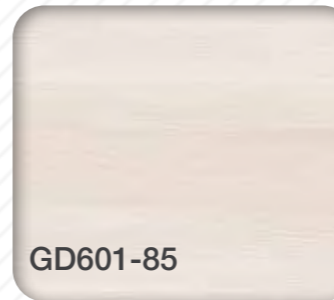

GD601-85



UR901-U3

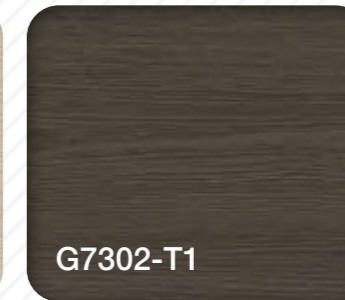

G7302-T1

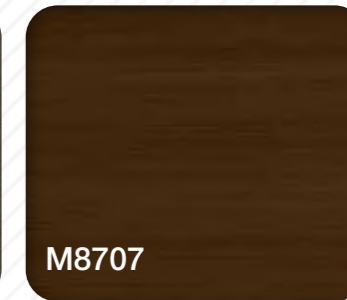

M8707



GB805-Q5



G4712-C2



MT104



FZ805



GD303-Q5



G6910-G8

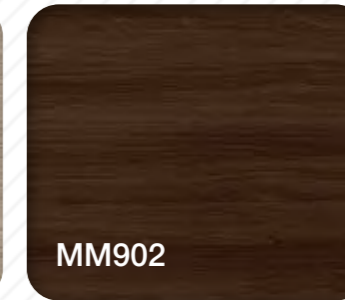

MM902



US201



GD603-85



A7004-F0



MQ808



WAR05

PHỤ LỤC  
**PHỤ KIỆN**  
 ACCESSORIES



1. GIÁ BÁT ĐĨA *FLOOR CABINET*

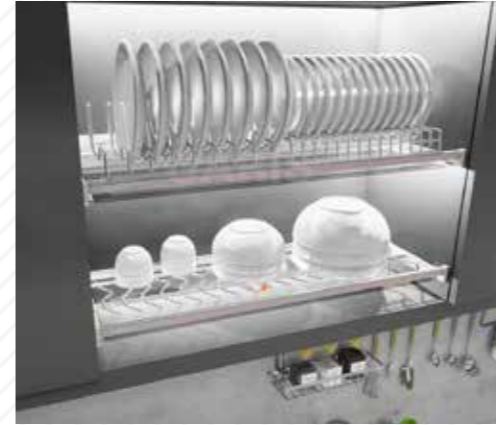

Quy cách (Rộng x Sâu x Cao) mm	Kích thước tủ tiêu chuẩn (mm)	Kích thước lọt lòng tủ (LW)mm
R564* S262* C67/155	600	564
R664* S262* C67/155	700	664
R764* S262* C67/155	800	764
R864* S262* C67/155	900	864



Quy cách (Rộng x Sâu x Cao) mm	Kích thước tủ tiêu chuẩn (mm)	Kích thước lọt lòng tủ (LW)mm
R664* S280* C550	700	664
R764* S280* C550	800	764
R864* S280* C550	900	864



Quy cách (Rộng x Sâu x Cao) mm	Kích thước tủ tiêu chuẩn (mm)	Kích thước lọt lòng tủ (LW)mm
R564* S280* C550	600	564
R664* S280* C550	700	664
R764* S280* C550	800	764
R864* S280* C550	900	864

## 2. GIÁ RAY TRƯỢT TOOL POCKET



Quy cách (Rộng x Sâu x Cao) mm	Kích thước tủ tiêu chuẩn (mm)	Kích thước lọt lòng tủ (LW)mm
R664* S462* C190	700	664
R764* S462* C190	800	764
R864* S462* C190	900	864



Quy cách (Rộng x Sâu x Cao) mm	Kích thước tủ tiêu chuẩn (mm)	Kích thước lọt lòng tủ (LW)mm
R564* S485* C190	600	564
R664* S485* C190	700	664
R764* S485* C190	800	764
R864* S485* C190	900	864



Quy cách Rộng x Sâu x Cao (mm)	Chiều rộng lọt lòng cánh kéo (mm)	Chiều rộng lọt lòng cánh mở (mm)
R245* S475* C555	LW: 255 - 304	LW: 300 - 349
R295* S475* C555	LW: 305 - 354	LW: 350 - 399
R345* S475* C555	LW: ≥ 355	LW: ≥ 400

## 3. GIÁ XOAY GÓC CORNER BASE CABINET



Góc mở	Đường kính	Kích thước lọt lòng tủ (mm)
--------	------------	-----------------------------

3/4 (270°)      Ø710

Chiều rộng tủ (LW) ≥ 750  
Khoảng hở cánh (LW1) ≥ 370  
Chiều cao: 555 - 775



Quy cách Rộng x Sâu x Cao (mm)	Kích thước lọt lòng tủ (mm)
-----------------------------------	-----------------------------

R810\* S390\* C(640 - 800)

Chiều rộng tủ (LW) ≥ 865  
Khoảng hở cánh (LW1) ≥ 425  
Chiều sâu (LD) ≥ 500  
Chiều cao: 640 - 800

## 4. TỦ KHO AREA STORAGE



Quy cách Rộng x Sâu x Cao (mm)	Kích thước tủ tiêu chuẩn (mm)	Kích thước lọt lòng tủ (mm)
-----------------------------------	----------------------------------	--------------------------------

R560\* S500\* C1780      600

Chiều rộng (LW) ≥ 565  
Chiều cao (LH) ≥ 600

## 5. KHAY CHIA THÌA Dĩa TRAY SYSTEM



Quy cách Rộng x Sâu x Cao (mm)	Kích thước ngăn kéo tiêu chuẩn (mm)
R530* S485* C55	600
R630* S485* C55	700
R730* S485* C55	800
R830* S485* C55	900



Quy cách Rộng x Sâu x Cao (mm)
R200* S473* C70
R280* S473* C70
R377* S473* C70

## 5. CHẬU RỬA SINK

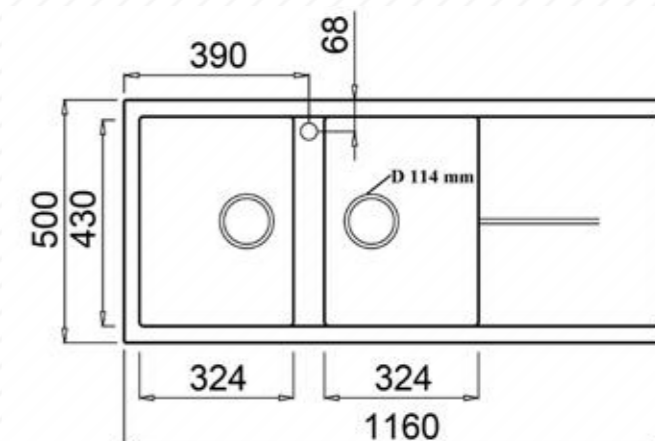
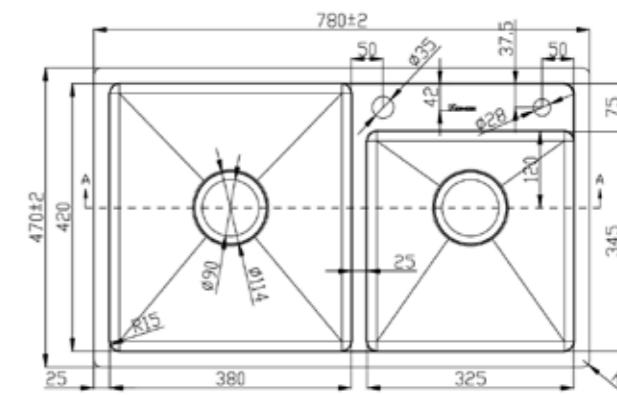
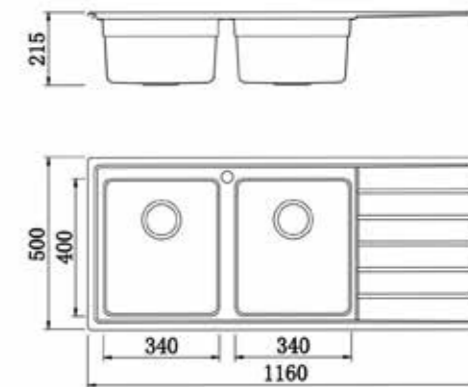

# HISUNG

INTERIOR

**Office & Factory:** LotP Binh Xuyen Industrial Zone, Vinh Phuc Province, Vietnam;

**Tel:** (84-24) 3212 3652 | **Hotline 1:** (84) 916 395 896;  
**Hotline 2:** (84) 916 765 896; **Hotline 3:** (84) 914 406 296

**HCM Office:** 60, Road 2nd, CityLand Residence, Ward 5th, Go Vap District, HCMC, Vietnam;

**Tel:** (84-28) 3516 5085 | **Hotline 1:** (84) 912 195 986;  
**Hotline 2:** (84) 912 195 989;

**Danang Office:** 363 Nguyen Huu Tho Street, Khue Trung Ward, Cam Le District, Danang, Vietnam;

**Tel:** (84-236) 3789 629 | **Hotline:** (84) 915 518 096

**Nhatrang Office:** 2nd Floor, Palm Residences Tower, 238 Ngo Gia Tu Street, Phuoc Tien Ward, Nha Trang, Khanh Hoa Province, Vietnam; **Tel:** (84-258) 3511 125 |

**Hotline:** (84) 913 995 896